

27 789 970









- Getto a doccia
- deviatore automatico rubinetto/batteria doccetta professionale
- altezza rubinetteria 665 mm
- rosetta separata Ø 55mm
- diametro foro doccetta professionale 30mm
- testina doccetta con sistema anticalcare
- senza piombo

Abbinabile soltanto al 33826790, 32800790, 33826888, 32815888, 20815892, 33826875.

Compatibile con: ELIO, TARA, TARA ULTRA

Sistema di sicurezza antiriflusso.

	Platinato spazzolato	27 789 970-06
	Cromato	27 789 970-00
	Platinato	27 789 970-08
	Dark Chrome	27 789 970-19
	Cromo spazzolato	27 789 970-93
	Dark Platinum spazzolato	27 789 970-99

27 789 970

mm [inches]
M 1:10



Diagramma di portata



Certificati

LGA_18901.

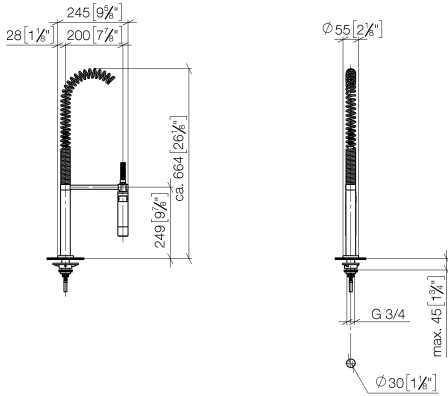
LGA_28304.

Belgaqua_22_277_2
7_3.

27 789 970

Parts for other finishes can be found here: Cromato

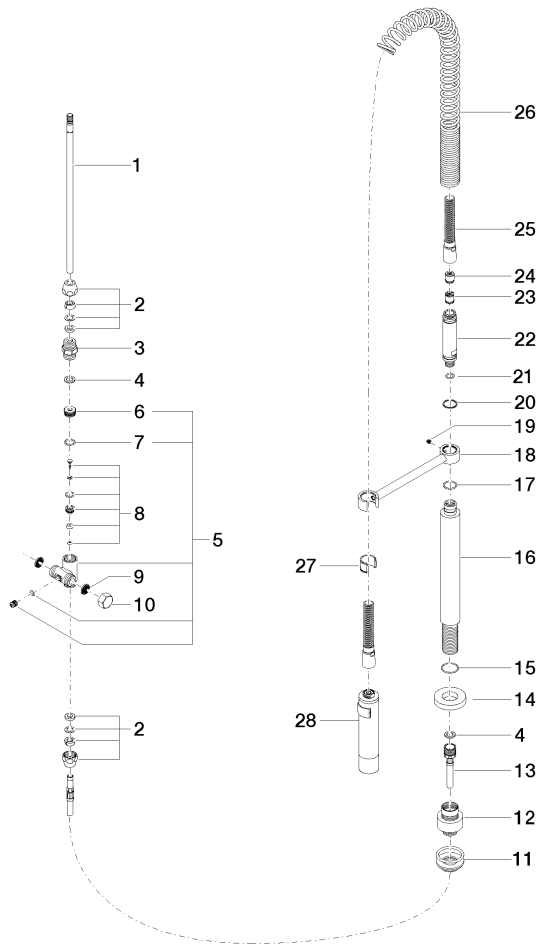

27 789 970

Elenco delle parti di ricambio

N.	Codice articolo	Denominazione	Quantità necessaria	Tempo di produzione
1	04 24 02 046 01-07	tubo	1	10
2	90 23 30 040 00-06	giunto a vite	2	10
3	90 24 03 168 00 90	ugello	1	2
4	90 14 20 002 00 90	guarnizione	2	2
5	90 17 09 046 10 90	deviatore	1	2
6	09 24 04 112 10 90	ugello	1	2
7	90 14 10 033 00 90	guarnizione	1	2
8	90 21 10 031 10 90	deviatore	1	2
9	09 23 01 039 90	setaccio	2	2
10	04 21 02 006 00 92	calotta	1	2
11	04 23 10 004 03 90	set di fissaggio	1	2
12	12 780 970 90	Set di prolunga -	1	60
13	09 30 04 067 90	flessibile	1	2
14	09 28 10 064-06	rosetta	1	10
15	09 14 10 120 90	guarnizione	1	2
16	09 11 10 066 10-06	attacco	1	10
17	09 14 10 031 90	guarnizione	1	2
18	04 17 20 014 00-06	sostegno	1	10
19	09 31 11 049 90	perno	1	2
20	09 14 15 012 90	anello	1	2
21	09 14 10 003 90	guarnizione	1	2
22	09 30 01 067 10-06	adattatore	1	10
23	90 23 01 141 00 90	valvola di non ritorno	1	2
24	09 23 01 046 90	valvola di non ritorno	1	2
25	90 30 02 065 00-06	flessibile	1	10
26	09 16 02 034 90	molla	1	2
27	90 18 40 035 00 90	bussola	1	2
28	04 12 11 094 10-06	doccia	1	10